

Data Sheet



Article number: 0125081

Description: Retaining ring SP68
Spring steel

Measures

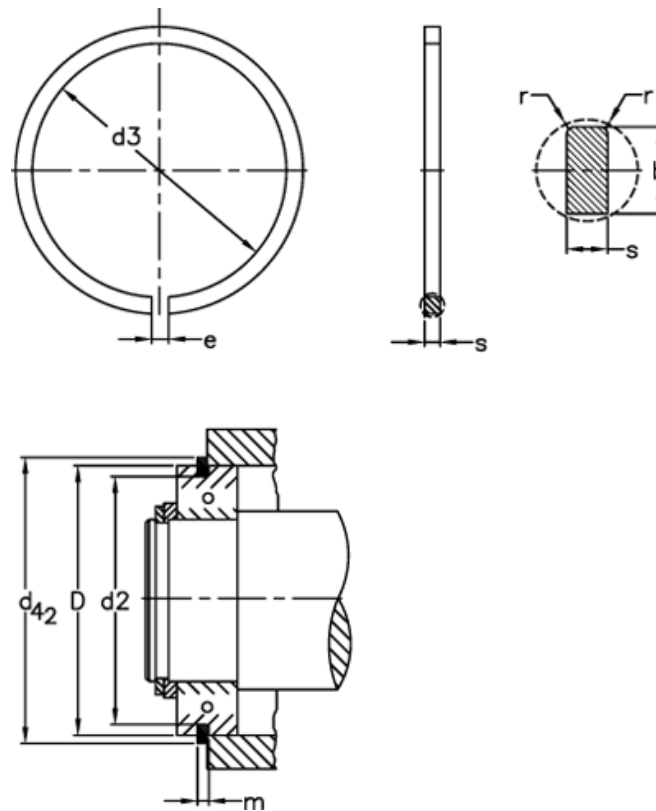

b	= 4.85	FRg kN	= 7.06	tol	= -0.15
D	= 68	FR kN	= 40.9	tol	= -0.1
d2	= 64.82	g	= 2.5	tol	= -0.50
d3	= 63.4	K kN-mm	= 75.0	tol	= 0.3
d42	= 74.6	m	= 1.90	tol	= 0.8
Description	= SP 68	n abl x 1000	= 4.0	Weight kg/1000	= 12.6
e	= 5	r min	= 0.6		
FN kN	= 55.5	s	= 1.70		